

Pump models

T30 T225

T80 T425

T125

Sanitary series

English



CE **Instruction manual**

Air operated diaphragm pumps

topflo®

Sanitary design pumps in
AISI 316L stainless steel

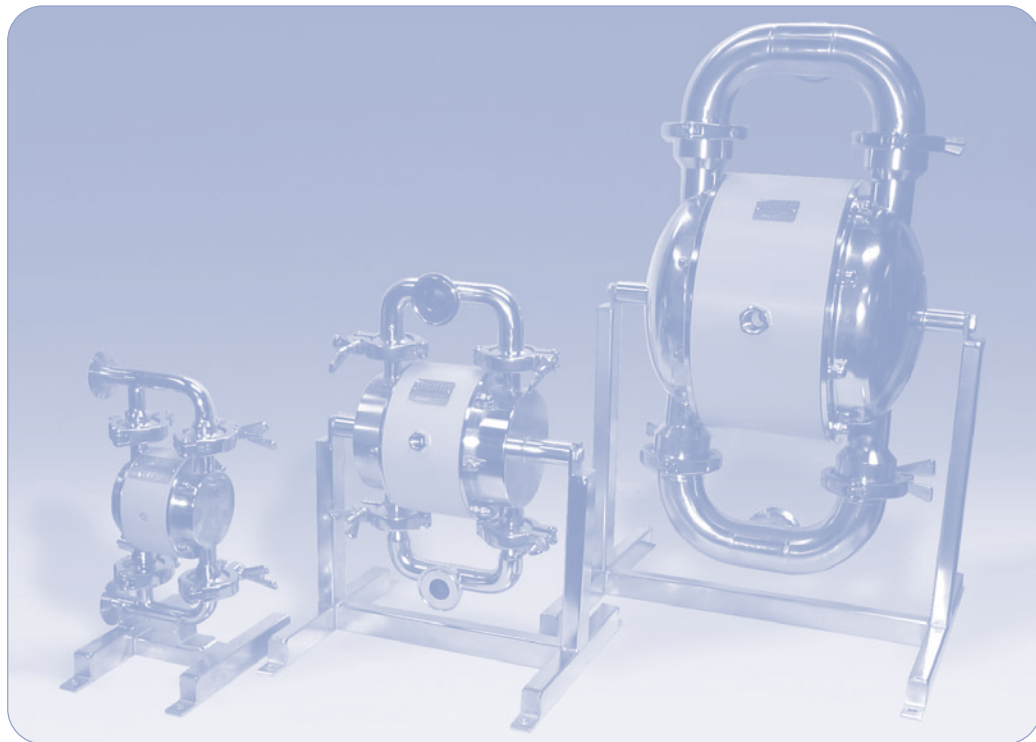

- ▶ Instructions for installation, start up, operation, maintenance and repair
- ▶ Spare parts



Read this instruction manual carefully, before you install and operate the pump

CONTENTS

CE CERTIFICATE	3	3.6 T30 - Assembly of the pump	11
0 GENERAL	4	3.6.1 Center block	11
0.1 Introduction	4	3.6.2 Assembling of the main units	11
0.2 The warning symbols	4	3.6.3 Test run	11
1 INSTALLATION	5	3.7 T80-T425 - Dismantling the pump	12
1.1 Receiving inspection	5	3.7.1 Before the dismantling procedure	12
1.2 Storage	5	3.7.2 Mainparts	12
1.3 Foundation	5	3.7.3 Center block	12
1.4 Suction and discharge pipings	5	3.8 T80-T425 - Assembly of the pump	13
1.4.1 Connection of suction pipe	5	3.8.1 Center block	13
1.4.2 Connection of discharge pipe	5	3.8.2 Assembling of the main units	13
1.5 Air connection	5	3.8.3 Test run	13
1.5.1 Air treatment system	6	4 SPARE PARTS	14
1.6 Example of installation	6	4.1 T30 - Drawing and spare part list	14
1.7 Recommended installations	6	4.2 T80-T425 - Drawing and spare part list	15
1.7.1 Flooded	6	4.3 Stocking recommendation	16
1.7.2 Selfpriming	6	4.4 How to order parts	16
2 OPERATION	7	4.5 Pump code	16
2.1 Health and safety	7	5 DATA	17
2.1.1 Protection	7	5.1 Capacity curves	17
2.1.2 Environments in danger of explosion	7	5.2 Capacity changes	17
2.1.3 Air pressure	7	5.3 Dimensions and technical data	18
2.1.4 Noise level	7	5.4 Tightening torques	18
2.1.5 Temperature hazards	7	6 WARRANTY & REPAIR	19
2.2 Before starting the pump	7	6.1 Warranty form	19
2.3 Starting and operating	8	6.2 Returning parts	20
2.3.1 Dry running	8	6.3 Warranty	20
2.3.2 Optimizing the pump lifetime	8		
2.4 Pump stopping	8		
2.5 Cleaning of the pump	8		
2.5.1 CIP - Clean in place	8		
3 MAINTENANCE	9		
3.1 Performance test	9		
3.2 Routine inspection	9		
3.3 Complete inspection	9		
3.4 Location of faults	9		
3.5 T30 - Dismantling the pump	10		
3.5.1 Before the dismantling procedure	10		
3.5.2 Mainparts	10		
3.5.3 Center block	10		

Declaration of conformity

Machinery directive 89/392/EEC, Annex 2A

Tapflo AB declares that:

Product name: **Air operated diaphragm pumps**
Models: **T...**

Is in conformity with the essential health and safety requirements and technical construction file requirements of the EC Machinery directive 89/393/EEC with amendments 91/368/EEC, 93/44 EEC and 93/68 EEC.

Manufacturer: **Tapflo AB**

Address: **Filaregatan 4
S-442 34 Kungälv
Sweden**

Tapflo AB, september 1st 1999



Börje Johansson
Managing director

▶ 0. GENERAL

0.1 Introduction

The Tapflo Air Operated Diaphragm Pump range is a complete series of pumps for industrial applications. The pumps are designed to be safe simple and easy to use and maintain. The construction is sealless and without rotating parts. The pumps are suitable for a variety of duties in hygienic installations.

With proper attention to maintenance, Tapflo Pumps will give efficient and trouble free operation. This instruction manual will familiarise operators with detailed information about installing, operating and maintaining the pump.

0.2 The warning symbols

The following warning symbols are present in this instruction manual. This is what they say.



This symbol stands next to all safety instructions in this instruction manual where danger to life and limb may occur. Observe these instructions and proceed with utmost caution in these situations. Inform also other users of all safety instructions. In addition to the instructions in this instruction manual, the general safety and accident prevention regulations must be observed.



This signal stands at points in this instruction manual of particular importance for compliance with regulations and directives, for correct work flow and for the prevention of damage to and destruction of the complete pump or its subassemblies.

▶ 1. INSTALLATION

1.1 Receiving inspection

Although precaution is taken by us when packing and shipping, we urge you to carefully check the shipment on receipt. Make sure that all parts and accessories listed on the packing list are accounted for. Immediately report any damage or shortage to the transport company and to us.

1.2 Storage



If the equipment is to be stored prior to installation, place it in a clean location. Do not remove the protective covers from the suction, discharge and air connections which have been fastened to keep pump internals free of debris. Clean the pump thoroughly before installation.

1.3 Foundation



The support of the pump is furnished with mounting holes. Fix the pump on a stable foundation, which is able to absorb vibrations. It is essential for the operation of the pump to mount the pump with the feet in a downward direction (see sketch in chapter 1.6).

1.4 Suction and discharge pipings

Suction and discharge piping should be fully supported and anchored near to but independent of the pump. The piping to the pump should be a hose, to prevent undue stress and strain on the pump connections and the pipings.

1.4.1 Connection of suction pipe

Remember that the suction pipe/connection is the most critical point, especially if the pump is priming. Just a small leakage will dramatically reduce the suction capability of the pump. When connecting the suction pipe, following is recommended.

- 1) For satisfactory operation, use reinforced hose (the suction power may otherwise shrink the hose) or other flexible piping. The internal diameter of the hose should be the same as on the suction connection (at the bottom of the pump) to have best suction capability.
- 2) Make sure that the connection hose - pump is completely tight, otherwise the suction capability will be reduced.
- 3) Always use as short suction pipe as possible. Avoid air pockets which can arise with long pipings.

1.4.2 Connection of discharge pipe



For this connection it is only recommended a simple and positive flow connection. Use a hose or flexible piping (minimum one meter) between the discharge connection and any rigid fixed piping. Coil the hose at least one turn. All components (hose, pipe, valves etc) on the discharge piping must be designed for minimum PN 10.

1.5 Air connection

Screw the air hose into the air intake on the center block of the pump with for example a bayonet coupling. For best efficiency, use the same hose diameter as the internal diameter of the connection on the air intake.

▶ 1. INSTALLATION

1.5.1



Air treatment system

The air valve is constructed for oilfree air. Lubrication of the air is **not allowed**. However, if the air is **very dry** (laboratory air), the air may be lubricated with water. Maximum air pressure is 8 bar. As prevention purpose, a filtration of the air by means of a 5 micron filter or finer is recommended. Dirt in the air can under unfortunate circumstances be the cause of breakdown.

To facilitate the operation of the pump we recommend an air treatment system connected to the air supply. These components should be included:

- 1) Regulator to adjust the air pressure
- 2) Manometer to read the actual pressure
- 3) Needle valve to adjust the air flow
- 4) Filter

These components are included in Tapflos **Air treatment system** which can be ordered from us.

1.6 Example of installation

- 1) Gate valve compressed air
- 2) Filter and pressure regulator
- 3) Flexible hose
- 4) Needle valve
- 5) Flexible piping
- 6) Gate valve suction
- 7) Gate valve discharge
- 8) Coiled flexible piping
- 9) Flow gauge

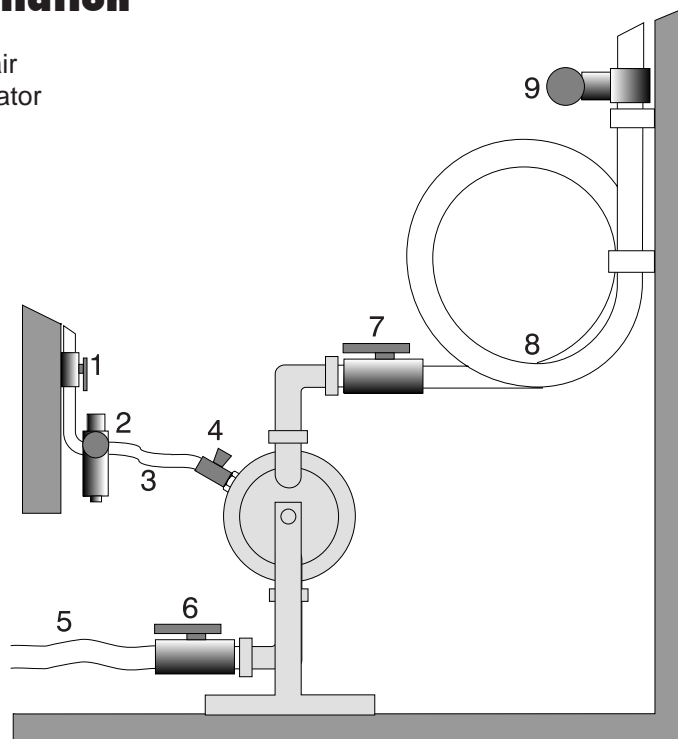

1.7 Recommended installations

The Tapflo pump is flexible in the way you are able to install it.

1.7.1 Flooded

The piping system is designed with a positive suction head. This is the best way of installation where it is necessary to completely evacuate all liquid from the container, or where viscous (thick) products are transferred.

1.7.2 Selfpriming

The Tapflo pump is designed to pull a high vacuum. It is able to evacuate an empty suction pipe without any damage to the pump. The suction lift is up to 5 meter (16.4 ') from an empty suction pipe and up to 8 meter (26.2') from a wetted pipe. The suction capability depends on the pump size (see chapter 5)

▶ 2. OPERATION

2.1 Health and safety

The pump must be installed according to local and national safety rules.



The pumps are constructed for particular applications. Do not use the pump on applications different from that for which it was sold without consulting us to ascertain its suitability.

2.1.1 Protection



In the interest of health and safety it is essential to wear protective clothing and safety goggles when operating, and/or working in the vicinity of Tapflo pumps.

2.1.2 Environments in danger of explosion



The standard stainless steel series pumps are not allowed to operate in environments in danger of explosion. Static electricity may occur in the pump under operation, which may cause explosion and injury. Special ATEX approved pumps are available for such applications. Consult Tapflo AB for further information. Follow the explosion safety rules applicable at the location for the pump.

2.1.3 Air pressure

The maximum air pressure for Tapflo pumps is 8 bar. Higher air pressure than 8 bar can damage the pump and may cause injury to personnel in vicinity of the pump. If you intend to apply a higher air pressure than 8 bar, please consult us.

2.1.4 Noise level



At tests, the noise level from a Tapflo pump has not exceeded 80 dB(A). Under some circumstances, for example if the pump is operating under high air pressure at low discharge head, the noise can be inconvenient or hazardous for personnel staying for long periods in vicinity of the pump. This hazard can be prevented by:

- using suitable ear protection
- lower the air pressure and/or raise the discharge head
- lead the outcoming air from the place by connecting a hose from the muffler connection of the pump.
- use elastomer valve balls (EPDM, NBR or polyurethane) instead of PTFE, ceramic or stainless steel, provided that the elastomer is compatible with the pumped liquid.

2.1.5 Temperature hazards

Raised temperature can cause damage on the pump and/or pipings and may also be hazardous for personnel in the vicinity of the pump/pipings. Avoid quick temperature changes and do not exceed the maximum temperature specified when the pump was ordered. See also general max temperatures based on water in chapter 5 "Data".

2.2 Before starting the pump



- Make sure the pump is installed according to the installation instruction (section 1).
- Filling of the pump with liquid before start is not necessary.
- When installation is new or reinstalled, a test run of the pump with water should be conducted to make sure the pump operates normally and does not leak.

▶ 2. OPERATION

2.3 Starting and operating

- Open the discharge valve.
- **Note! Considering the suction capacity when air is still in the suction pipe, it is recommended to start with low air pressure/flow in the beginning. This is not necessary if the pump is filled with liquid before start.**
- When the pump has been filled with liquid, the air pressure/flow may be raised to increase the suction capacity of the pump.
- The performance of the pump can be adjusted through the air supply by using a needle valve and a pressure regulator. The performance can also be adjusted by normal flow control on the discharge side of the system.

2.3.1 Dry running

The pump may run dry without any problem.

2.3.2 Optimizing the pump lifetime

Running at full frequency (maximum air pressure/flow) continuously will cause premature wear of the components. As a general rule, we recommend to run at half of the maximum capacity of the pump. For instance, a T80 pump should run continuous maximum at 40 l/min.

2.4 Pump stopping

The pump can be stopped in two ways:

- 1) Close the discharge valve. The pressure from the system will stop the pump automatically. This will not do any damage to the pump. The pump restarts easy when the valve is opened again.
- 2) Stop the air supply.

2.5 Cleaning of the pump

2.5.1 CIP - Clean in place

The importance of easy cleaning is especially great in hygienic applications. Tapflo stainless steel pumps are designed for CIP (clean in place). This allows the pump to be internally cleaned without strip down. The pump can be cleaned by flushing through with a CIP fluid (usually a mild solution of sodium hydroxide and a sanitizing additive) or by injection of hot steam. The CIP fluid temperature varies, but in the sanitary field, the temperature is usually about 90°C. Make sure that the CIP fluid is compatible with the materials in the pump/piping (consult us for further information).

The solution is passed through the system by either from the operation of the pump itself, or by a centralized cleaning system. The CIP fluid must pass through the pump at a minimum velocity of 1.5 m/s in the normal flow direction (from inlet to outlet).

2.5.1.1 Drainage of the pump (T80-T425)

After the CIP procedure, the pump usually has to be drained from the CIP fluid. The Tapflo stainless steel series is supplied with a hygienic stand, enabling 360° rotation of the pump unit.

- 1) Disconnect the pump from the pipings.
- 2) Simply loosen the two socket head cap screws (pos 4) and rotate the pump 180° and let the remaining fluid drain off. The airline may be left connected during this rotation.
- 3) Rotate back to normal position, connect the pump with the pipings and fix the socket head cap screws (pos 4).

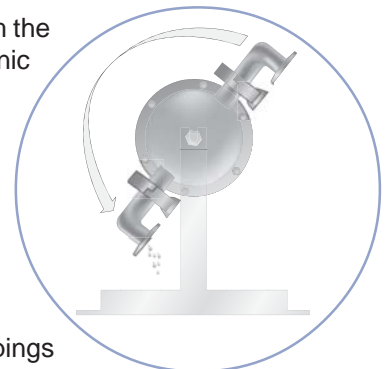

▶ 3. MAINTENANCE

3.1 Performance test

When installation is new, a test run of the pump should be conducted. Gauge the capacity at specific air pressure/flow. This information is for use in checking performance as wear takes place. You will be able to set schedules for maintenance of the pump and to select spare parts to be kept on stock.

3.2 Routine inspection



Frequent observation of the pump operation is recommended to detect problems. A change in sound of the running pump can be an indication of worn parts (see below "location of faults"). Leaking liquid from the pump and changes of performance may also be detected. Routine inspections should be conducted frequently.

3.3 Complete inspection



The intervals for a complete inspection depend upon the operation conditions for the pump. The characteristics of the liquid, temperature, materials used in the pump and running time decide how often a complete inspection is necessary.

If a problem has occurred, or if the pump is in need of a complete inspection, see later this chapter "location of faults" and "dismantling of the pump". You are of course warmly welcome to consult us for further help.

Worn parts should be carried in stock, see our recommendation in chapter 4.

3.4 Location of faults

Problem	Possible fault
The pump does not run	The air pressure is too low The air connection is blocked Muffler is blocked Air valve is defect Dirt in the pump chamber Diaphragm breakdown
The suction is bad	Suction connection is not tight Suction connection is blocked Muffler is blocked Valve balls are blocked Valve balls are damaged
The pump runs irregularly	Valve balls are blocked Sealings are defect in air valve or center block Diaphragm breakdown
Bad flow/pressure	Pressurefall in incoming air Suction or air connection blocked Muffler is blocked Air valve is defect Valve balls worn out/broken Air in liquid Diaphragm breakdown
Liquid leaks from the pump	Screws on the housing not properly fastened
Liquid comes out of the muffler	Diaphragm breakdown

▶ 3. MAINTENANCE

3.5 T30 - Dismantling the pump

3.5.1 Before the dismantling procedure



Be sure to drain all liquid from the pump. Cleanse or neutralize the pump thoroughly. Disconnect the air connection and then the suction and discharge connections.

The numbers put in brackets refer to the positions on the assembly drawing.

3.5.2 Mainparts

- 1) Unscrew and remove the two upper clamps (138) from the pump. Remove the outlet manifold (132), valve balls (23) and sealings (18).
- 2) Hold the pump when you unscrew and remove the two lower clamps (138) and carefully lift off the pump housing assembly. Take out the valve balls (23) and seals (18) from the inlet manifold.
- 3) Unscrew and release the domed nuts (37) from one side of the pump. Place the pump with the housing (11) that still has the nuts on downwards. Then lift off the loose housing from the centerblock unit and then carefully pull the centerblock unit from the remaining housing with pin screws (14).

3.5.3 Center block

- 1) Press the diaphragms (15) to their neutral position (both have the same distance to the center block).
- 2) Hold one of the diaphragms and unscrew the other. Then pull out the remaining diaphragm with the diaphragm shaft (16).
- 3) Place the center block on a clean place. Observe that this is a faying surface, so be careful not to damage it. Pull out the circlip (27) carefully with pliers so it will not hurt you or disappear.
- 4) Turn the center block. Pull out the other circlip (27).
- 5) Press carefully out the air valve from the housing. Use a pressing device for this operation for the best result. The main piston and air valve housing will slowly come out. Observe that the brass is soft material and changes figure easy. If those details are deformed they must be changed, so handle those with care.

The pump is now completely dismantled. Check all components for wear or damage and replace if necessary.

▶ 3. MAINTENANCE

3.6 T30 - Assembly of the pump

3.6.1 Center block

- 1) Mount the circlip (27) on one side. Put some soft soap solution on the air valve o-rings (30) and then carefully push the air valve (61) into the housing. It is recommended to use a pressing device for this operation. Make sure that the o-rings (30) remain in the right position. Put the circlip (27) on the other side.
- 2) Put the diaphragm (15) with shaft (16) into the center block. Screw the next diaphragm (15) onto the shaft (16) and fix the holes. Sometimes you have to turn the diaphragms a little back to get the holes fixed.

3.6.2 Assembling of the main units

The housing is assembled in opposite order to dismantling.

- 1) Make sure all pin screws (14) have a domed nut (37) each. Nut should only be put on one or two threads.
- 2) Place one of the housings on the centerblock and then gently put all the pin screws through the housing and centerblock. Make sure that the housing is in the correct position (the inlet pipe of the housing has a cylindrical valve ball stopper). Be careful so that threads on screws do not damage the diaphragms when assembling.
- 3) Put on the remaining housing (11) onto the pin screws (14).
- 4) Fasten the domed nuts (37) by hand, then fasten alternately with a tool. After a few weeks operation a follow up draft of the nuts is recommended.
- 5) Put the seals (18) and valve balls (23) in position on the inlet manifold (131). Mount and fasten the lower clamps (138).
- 6) Place the sealings (18), valve balls (23) and then the outlet manifold (132) on the housing assembly.
- 7) Mount and fasten the upper clamps (138).

The pump is now ready for service and can be reinstalled in the system according to section 1 and 2 (installation and operation).

3.6.3 Test run

We recommend you to conduct a test run of the pump before installing it to the system so no liquid gets wasted if the pump leaks or perhaps does not start according to wrong assembling of the pump.

▶ 3. MAINTENANCE

3.7 T80-T425 - Dismantling the pump

3.7.1 Before the dismantling procedure



Be sure to drain all liquid from the pump. Cleanse or neutralize the pump thoroughly. Disconnect the air connection and then the suction and discharge connections.

The numbers put in brackets refer to the positions on the assembly drawing.

3.7.2 Mainparts

- 1) Unscrew and remove the clamps (138) from the pump. Carefully remove the manifolds (131 and 132), valve balls (23) and sealings (18).
- 2) Unscrew the socket head cap screws (174) and lift off the pump unit from the support (17).
- 3) Unscrew and release the domed nuts (37) from one side of the pump. Place the pump with the housing (11) that still has the nuts on downwards. Then lift off the loose housing from the centerblock unit and then carefully pull the centerblock unit from the remaining housing with pin screws (14).

3.7.3 Center block

- 1) Press the diaphragms (15) to their neutral position (both have the same distance to the center block).
- 2) Hold one of the diaphragms and unscrew the other. Then pull out the remaining diaphragm with the diaphragm shaft (16).
- 3) Place the center block on a clean place. Observe that this is a faying surface, so be careful not to damage it. Pull out the circlip (27) carefully with pliers so it will not hurt you or disappear.
- 4) Turn the center block. Pull out the other circlip (27).
- 5) Press carefully out the air valve from the housing. The main piston and air valve housing will slowly come out. Observe that the brass is soft material and changes figure easy. If those details are deformed they must be changed, so handle those with care.

The pump is now completely dismantled. Check all components for wear or damage and replace if necessary.

▶ 3. MAINTENANCE

3.8 T80-T425 - Assembly of the pump

3.8.1 Center block

- 1) Mount the circlip (27) on one side. Put some soft soap solution on the air valve o-rings (30) and then carefully push the air valve (61) into the housing. It is recommended to use a pressing device for this operation. Make sure that the o-rings (30) remain in the right position. Put the circlip (27) on the other side.
- 2) Put the diaphragm (15) with shaft (16) into the center block. Screw the next diaphragm (15) onto the shaft (16) and fix the holes. Sometimes you have to turn the diaphragms a little back to get the holes fixed.

3.8.2 Assembling of the main units

The housing is assembled in opposite order to dismantling.

- 1) Make sure all pin screws (14) have a domed nut (37) each. Nut should only be put on one or two threads.
- 2) Place one of the housings (11) on the centerblock and then gently put all the pin screws through the housing and centerblock. Make sure that the housing is in the correct position (the inlet pipe of the housing has a cylindrical valve ball stopper). Be careful so that threads on screws do not damage the diaphragms when assembling.
- 3) Put on the remaining housing (11) onto the pin screws (14).
- 4) Fasten the domed nuts (37) by hand, then fasten alternately with a tool. After a few weeks operation a follow up draft of the nuts is recommended.
- 5) Place the pump unit on the support and fasten the socket head cap screws (174) only by hand, so that the pump unit can be turned.
- 6) Turn the pump unit until the inlet side is upwards. Place the sealings (18), valve balls (23) and then the inlet manifold (131) on the housing inlets.
- 7) Mount and fasten the clamps (138).
- 8) Turn the pump unit and do the same procedure on the outlet side. Fasten the socket head cap screws (174).

The pump is now ready for service and can be reinstalled in the system according to section 1 and 2 (installation and operation).

3.8.3 Test run

We recommend you to conduct a test run of the pump before installing it to the system so no liquid gets wasted if the pump leaks or perhaps does not start according to wrong assembling of the pump.

4. SPARE PARTS

4.1 T30 - Drawing and spare part list

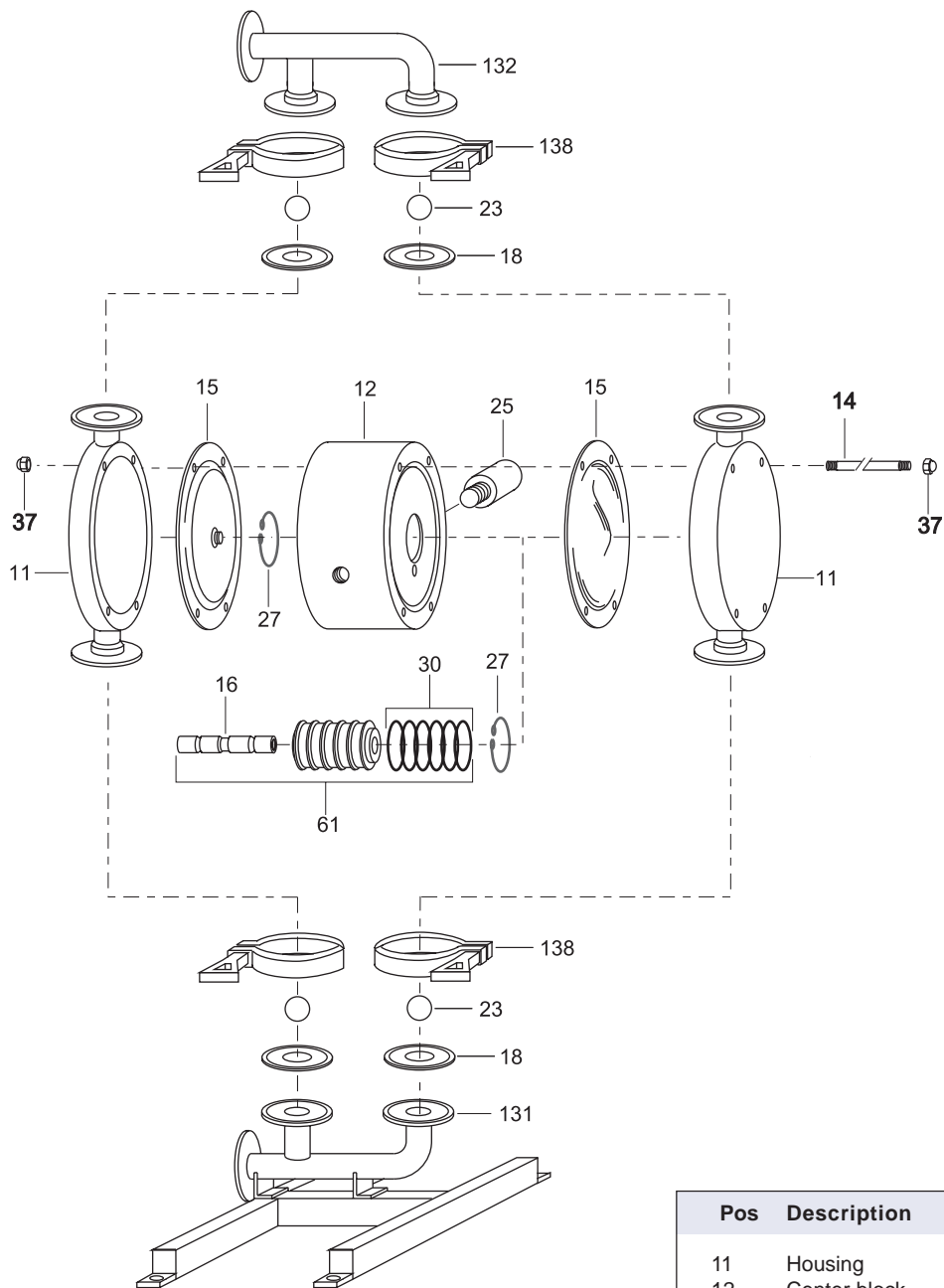

Pos	Description	Qty
11	Housing	2
12	Center block	1
131	Manifold inlet and stand	1
132	Manifold outlet:	1
138	3-clamp	4
14	Pin screw	4
15	Diaphragm	2
16	Diaphragm shaft	1
18	Sealing	4
23	Valve ball	4
25	Muffer	1
27	Circlip	2
30	O-ring	6
37	Domed nut	8
61	Air valve complete	1

4. SPARE PARTS

4.2 T80-T425 - Drawing and spare part list

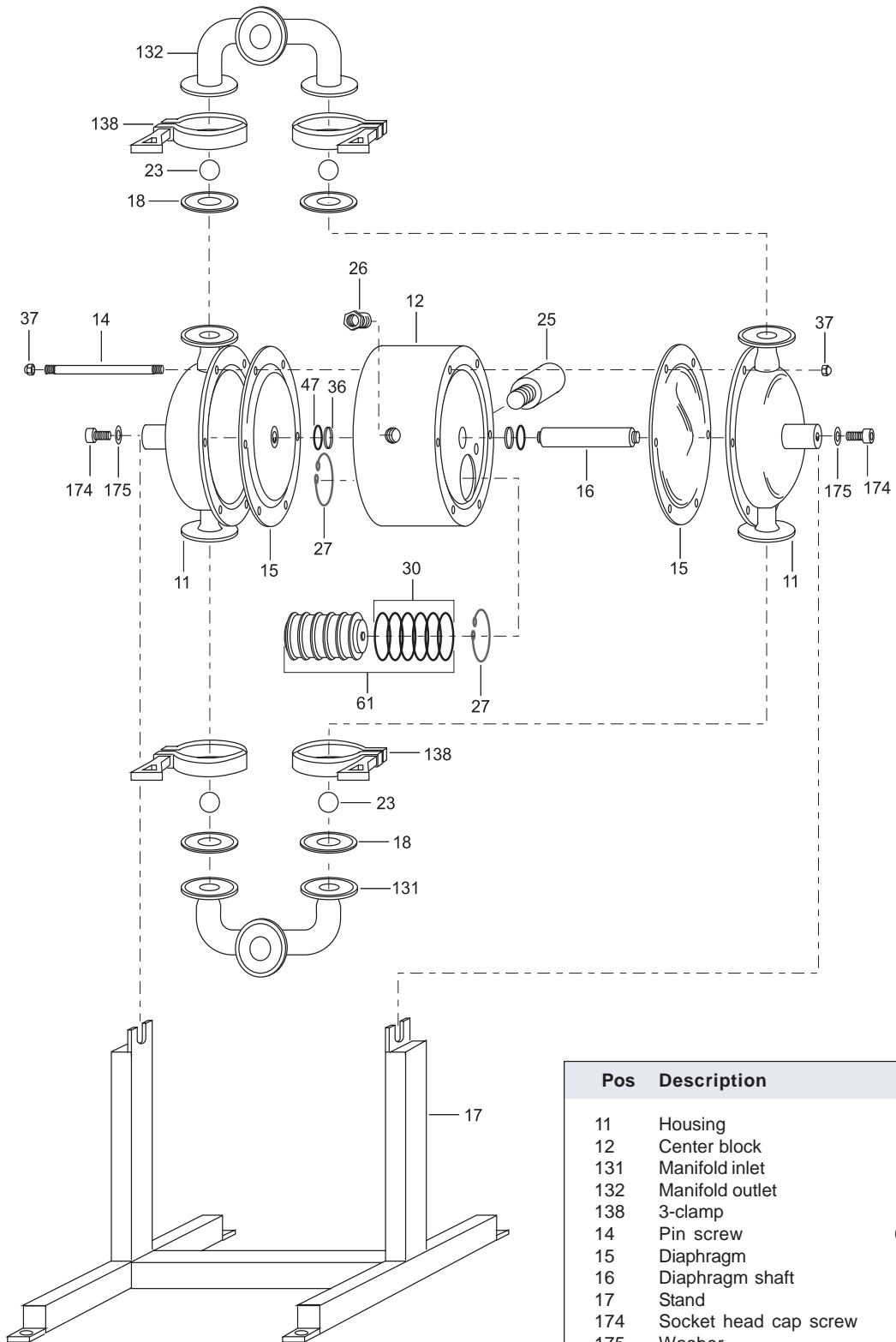

* = T80 and T125
 ** = T225 and T425
 *** = T125 only

Pos	Description	Qty
11	Housing	2
12	Center block	1
131	Manifold inlet	1
132	Manifold outlet	1
138	3-clamp	4
14	Pin screw	6*/8**
15	Diaphragm	2
16	Diaphragm shaft	1
17	Stand	1
174	Socket head cap screw	2
175	Washer	2
18	Sealing	4
23	Valve ball	4
25	Muffler	1
26	Air intake adapter	1
27	Circlip	2
30	O-ring	6
36	Center block sealing	2
37	Domed nut	12*/16**
47	O-ring (back up for 36)	2/4***
61	Air valve complete	1

▶ 4. SPARE PARTS

4.3 Stocking recommendation

Even at normal operation some details in the pump will be worn. In order to avoid expensive breakdowns we recommend having a few spare parts in stock.

Depending on the severity of the operation and the importance of not having a breakdown we offer two different spare part sets. When ordering a spare part set, the complete pump model number must be given to us (see this page "pump code").

Spare part set No 1

Qty	Description	Pos
2	Diaphragm	15
4	Valve ball	23
1	Muffler	25
4	Sealing	18

Spare part set No 2

Qty	Description	Pos
1	Spare part set No 1	-
1**	Diaphragm shaft	16
2	Circlip	27
2**	Center block seal	36
2**/4*	O-ring	47
1	Air valve complete	61

* = T125 only

** = Not for T30

4.4 How to order parts

When ordering spare parts for Tapflo Pumps, please let us know the **model number** from the nameplate of the pump. Then just indicate the part numbers (referred to the spare part list) and quantity of each item.

4.5 Pump code

The model number on the pump and on the front page of this instruction manual tells the pump size and materials of the pump components.

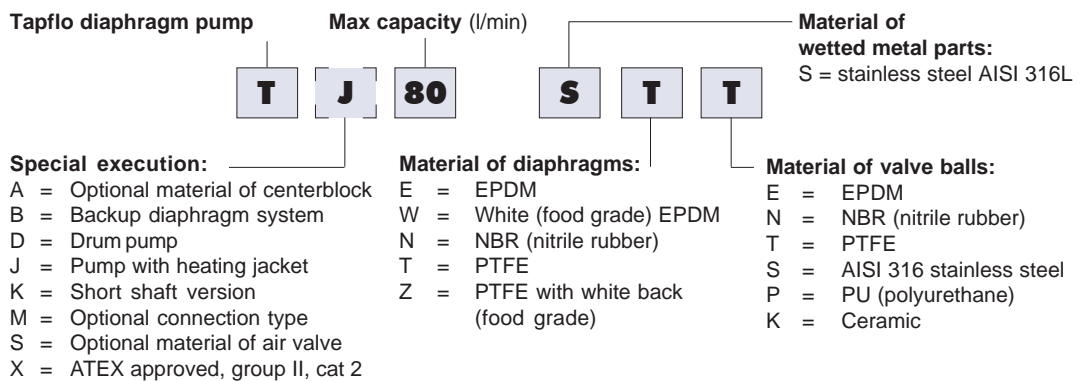

5. DATA

5.1 Capacity curves

The performance curves are based on water at 20°C. Other circumstances might change the performance. See below how the capacity will change at different viscosities and suction lifts.

Example (see the purple line below):

A flow of 30 liter/minute is desired. The discharge pressure is calculated to 2,5 bar. We choose a T80. It requires an air pressure of 4 bar and will consume approximately 0.18 m³ air per minute.

T30

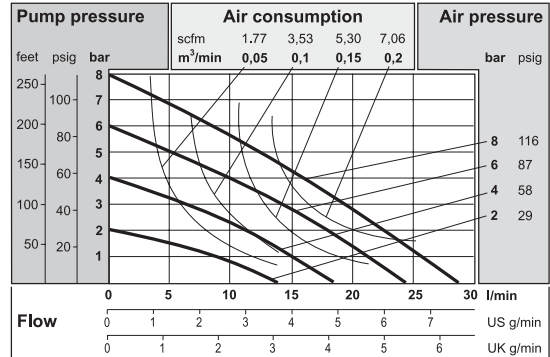

T80

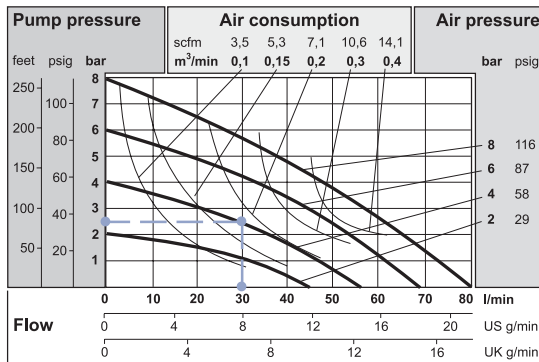

T125

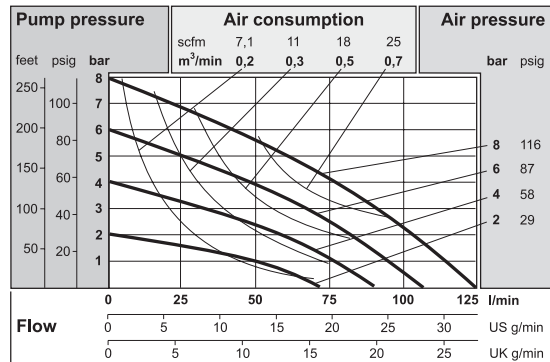

T225

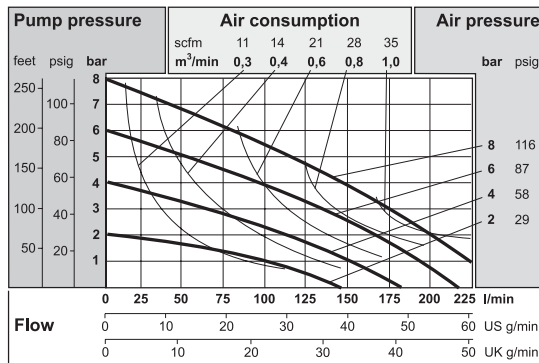

T425

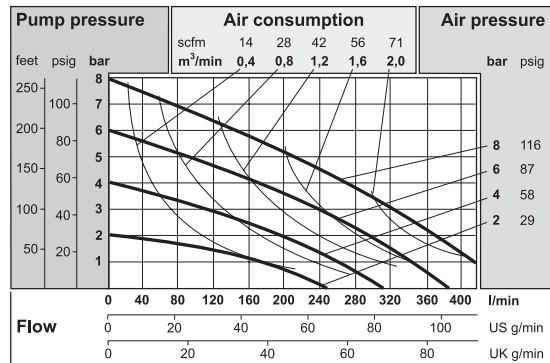

Recommended flow is half of the the max flow, i.e. recommended flow for a T80 is 40 l/min (10.6 US gpm).

5.2 Capacity changes

Capacity changes at different suction lifts

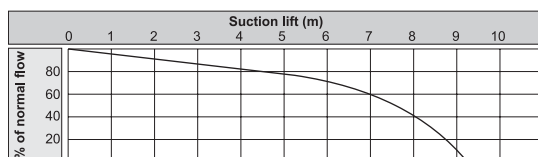

Capacity changes at different viscosities

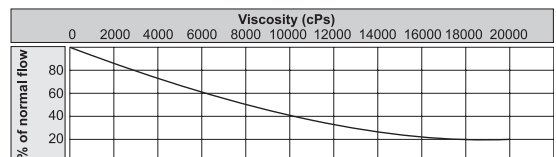

5. DATA

5.3 Dimensions and technical data

	Dim			Pump size	
	30	80	125	225	425
A	160	290	290	360	440
	6.30	11.4	11.4	14.2	17.3
B	230	295	320	420	485
	9.06	11.6	12.6	16.5	19.1
D	302	396	445	639	840
	11.9	15.6	17.5	25.2	33.1
E	241	297	349	514	698
	9.49	11.7	13.7	20.2	27.5
G	25	14	14	14	14
	0.98	0.6	0.6	0.6	0.6
I	48	73	71	86	97
	1.89	2.9	2.8	3.4	3.8
J TC ¹	3/4"	1"	1 1/2"	2"	2 1/2"
	DIN ²	DN25	DN40	DN50	DN65
SMS ³	-	25	38	51	63.5
	RJT	3/4"	1"	1 1/2"	2 1/2"
K	9	9	9	9	9
	0.4	0.4	0.4	0.4	0.4
ØM*	25	50.5	50.5	64	91
	0.98	2.0	2.0	2.5	3.6
ØN*	16.0	22.6	35.6	48.6	66.8
	0.63	0.9	1.4	1.9	2.6

Dimensions for sanitary series

Dimensions in mm (where other is not indicated)

Dimensions in inch (where other is not indicated)

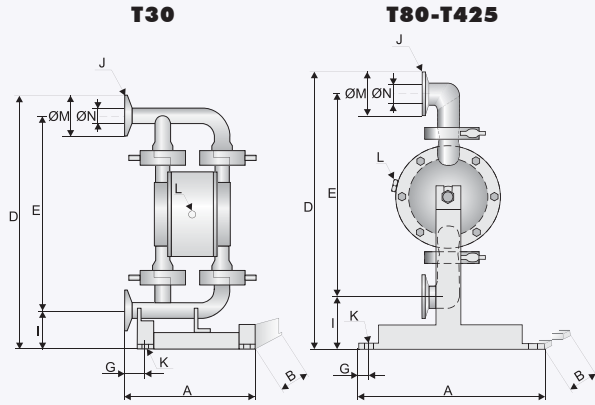

* = Dimensions for standard clamp connections only

1 = Clamp connections/pipes according to ISO 2852/2037

2 = Threaded connections according to DIN 11851

3 = Threaded connections according to SMS 1145

General dimensions only, ask us for detailed drawings. Changes reserved without notice

Technical data	Pump size				
	30	80	125	225	425
Max capacity (l/min) / (US gpm)	30 / 7.9	80 / 21	125 / 33	225 / 59	425 / 112
*Volume per stroke (ml) / (cu in)	70 / 4.3	140 / 8.5	300 / 18.3	700 / 42.7	2600 / 158
Max discharge pressure (bar) / (psi)	8 / 116	8 / 116	8 / 116	8 / 116	8 / 116
Max air pressure (bar) / (psi)	8 / 116	8 / 116	8 / 116	8 / 116	8 / 116
Max suction lift dry (m) / (Ft)	1.5 / 4.9	3 / 9.8	4 / 13	5 / 16	5 / 16
Max suction lift wet (m) / (Ft)	8 / 26	8 / 26	8 / 26	8 / 26	8 / 26
Max size of solids (ø in mm) / (in)	3 / 0.12	4 / 0.16	6 / 0.24	10 / 0.39	15 / 0.59
Max temperature (°C) / (°F)	110 / 230	110 / 230	110 / 230	110 / 230	110 / 230
Weight (kg) / (lb)	4 / 9	8 / 18	11 / 24	21 / 46	35 / 77
Material of components					
Wetted metal details	Stainless steel AISI 316L				
Centre block (not wetted)	PP				
Diaphragms	PTFE, PTFE with white back, EPDM, white EPDM, NBR				
Valve balls	PTFE, EPDM, NBR, AISI 316, PU, Ceramic				
Air valve	Brass / NBR or optional AISI 316L / FKM				
Sealings (wetted)	PTFE or EPDM				
Housing pin screws	Stainless steel AISI 304				
Diaphragm shaft	Stainless steel AISI 304				

* = The value is based on pumps with EPDM diaphragms. Pumps with PTFE diaphragms have about 15% less volume.

5.4 Tightening torques

The following tightening torques are recommended.

Pump size	Mounting torque (Nm)
T30	5.5
T80	8
T125	16
T225	20
T425	23

6. WARRANTY & REPAIR

6.1 Warranty form

Company: _____	
Telephone: _____	Fax: _____
Address: _____	
Country: _____	Contact name: _____
E-mail: _____	
Delivery date: _____	Pump was installed (date): _____
Pump type: _____	Serial No (stamped on the pump housing): _____
Description of the fault: _____	

The installation	
Liquid: _____	
Temperature (°C): _____	Viscosity (cPs): _____ Spec. grav. (kg/m ³): _____ pH-value: _____
Contents of particles: _____ %, of max size (mm): _____	
Flow (l/min): _____	Duty (h/day): _____ No of starts per day: _____
Discharge head (mwc): _____	Suction head/lift (m): _____
Air pressure (bar): _____	Quality of the air (filter, micron?, lubrication?): _____
Other: _____	

Place for sketch of the installation	

▶ 6. WARRANTY & REPAIR

6.2 Returning parts

When returning parts to Tapflo AB please follow this procedure:

- Consult Tapflo AB for shipping instructions.
- Cleanse or neutralize and rinse the part/pump. Make sure the part/pump is completely empty from liquid.
- Pack the return articles carefully to prevent any damage under transport.

Goods will not be accepted unless the above procedure has been complied with.

6.3 Warranty

Tapflo AB warrants products* of it's own manufacture will be free from defects in raw material and manufacture under normal use and service for a period of not more than one year. Tapflo's obligation under this warranty being limited to repair or replacement of its products which shall be returned to Tapflo AB. Follow the procedures above "returning parts". If a pump or part is received defected, report to Tapflo AB immediately. Parts returned to our company must have written authorisation from Tapflo AB. This warranty will not apply to any of our products which shall have been used other than for their intended use.

** Even when products such as diaphragm pumps operate under normal conditions, some parts are subject to wear and may have to be replaced within one year. Examples of such parts in Tapflo diaphragm pumps are; diaphragms, valve balls, o-rings and gaskets etc. This warranty will not apply to these parts being subject to wear.*

A large grid of graph paper for taking notes, consisting of 25 columns and 45 rows of small squares.

NOTES

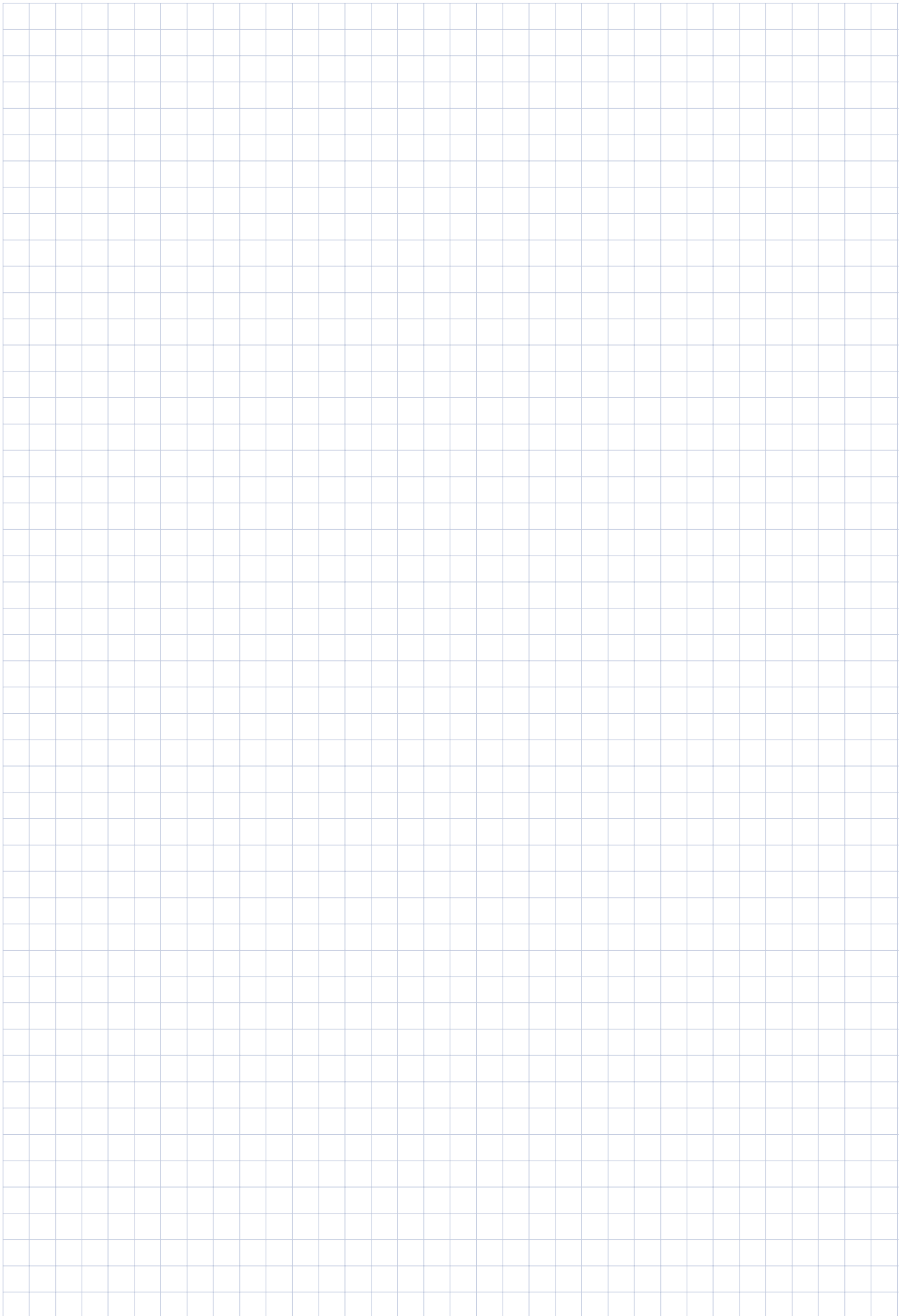

NOTES

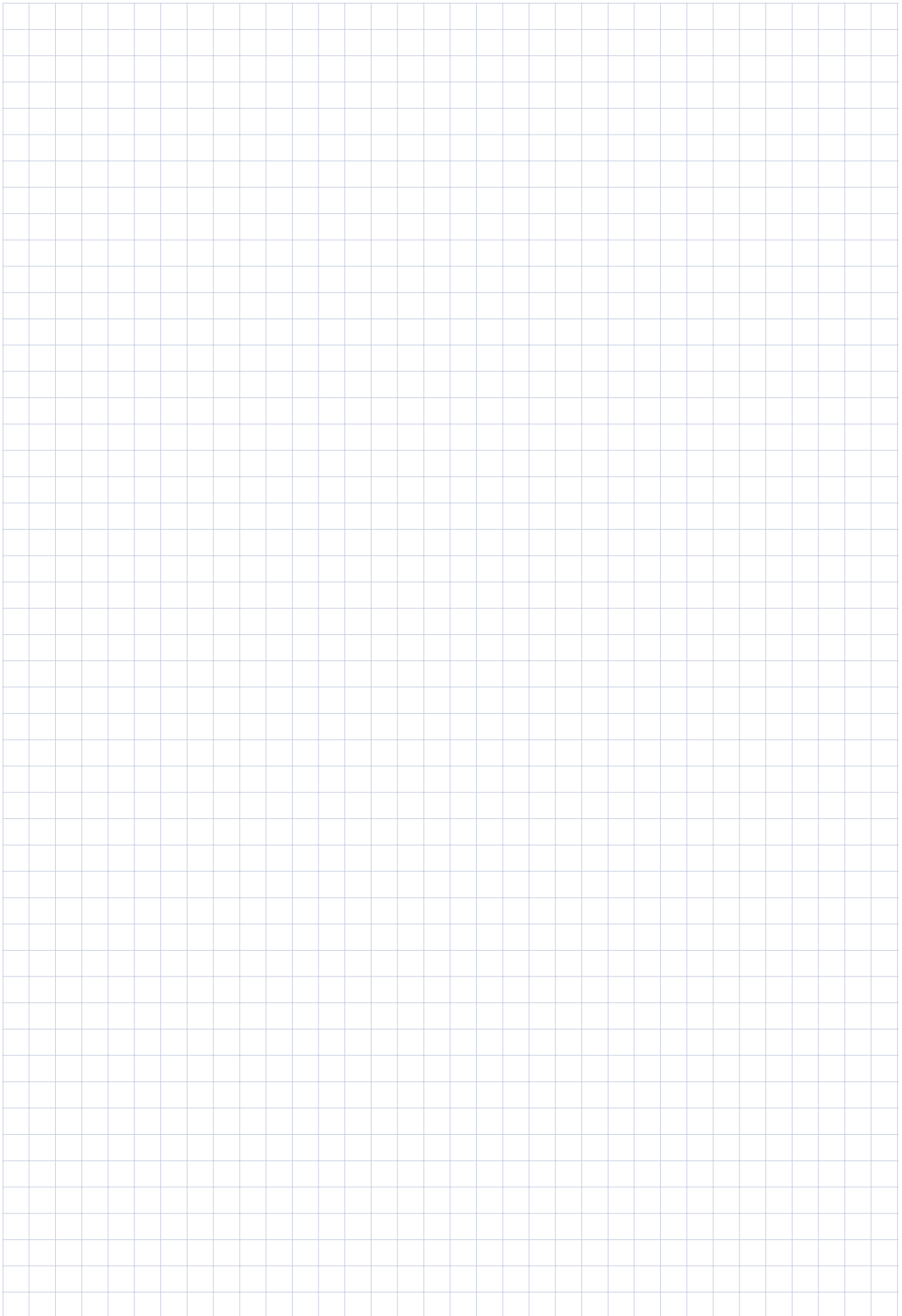



Tapflo AB • Filaregatan 4 • S-442 34 Kungälv • Sweden
Tel (46) 303 63390 • Fax (46) 303 19916 • E-mail: sales@tapflo.com • www.tapflo.com

DISTRIBUTOR: